



HOLLYLAND
MADE TO INSPIRE

LARK MAX

User Manual
V2.0.0

Introduction

Thank you for purchasing Hollyland LARK MAX wireless microphone system.
Please read this User Manual carefully before using the product.

Key Features

- Extremely compact, portable design
- 2 TX + 1 RX and 1 TX + 1 RX modes
- Multiple LARK MAX systems working together in the same environment with frequency hopping technology
- Built-in lithium battery with ultra-long operating time
- Charging case for storage and charging
- Automatic switch to the external microphone
- Professional-level wireless audio specifications
- Environmental Noise Cancellation (ENC) technology on the transmitter to eliminate environmental noise
- 2.4GHz digital wireless transmission to deliver crystal-clear sound
- Transmitter capability of working as a standalone recorder, with 8GB of built-in storage
- AMOLED touchscreen on the receiver to display recording status, wireless information, and more

Interface Description

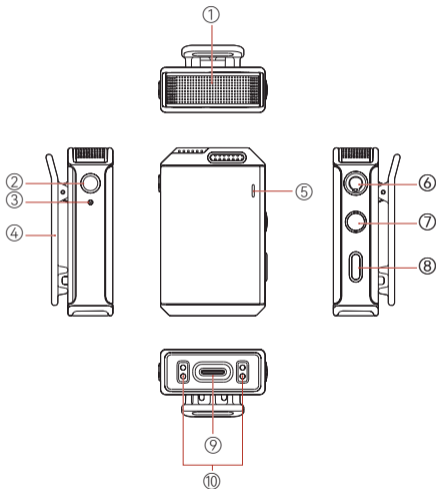

A: Transmitter

- ① Built-in Microphone
- ② REC Button
- ③ REC Indicator
- ④ Back Clip
- ⑤ Status Indicator
- ⑥ 3.5mm Audio Input Interface
- ⑦ Power Button
- ⑧ Pairing/Noise Cancellation Button
- ⑨ USB-C Interface
- ⑩ Contacts

Interface Description

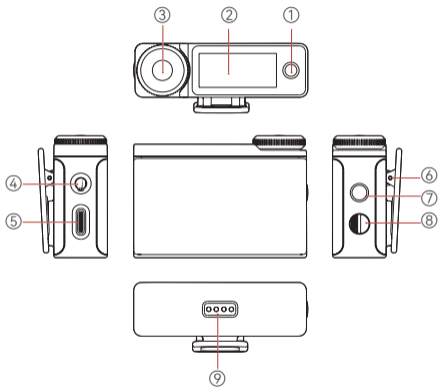

B: Receiver

- ① On-Screen Home Button
- ② AMOLED Touchscreen
- ③ Control Knob
- ④ 3.5mm TRS Headphone Interface
- ⑤ USB-C Interface
- ⑥ Back Clip
- ⑦ Power/Screen Lock Button
- ⑧ 3.5mm TRS Audio Output Interface
- ⑨ Contacts

Interface Description

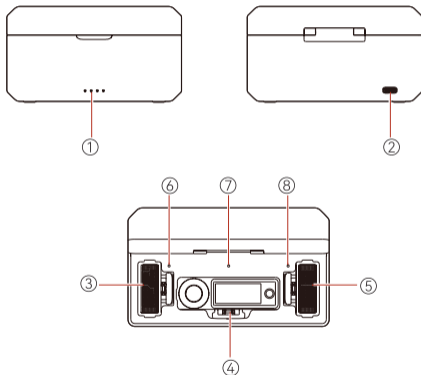

C: Charging Case

- ① Charging Case Battery Level Indicator
- ② USB-C Interface
- ③ Transmitter 1 Charging / Storage Slot
- ④ Receiver Charging / Storage Slot
- ⑤ Transmitter 2 Charging / Storage Slot
- ⑥ Transmitter 1 Charging Indicator
- ⑦ Receiver Charging Indicator
- ⑧ Transmitter 2 Charging Indicator

Display Description

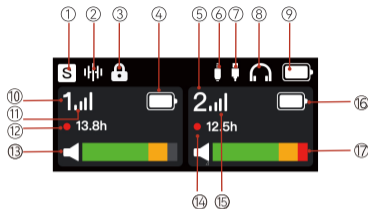

A: Receiver Main Interface (Outside the Charging Case)

① Recording Mode	⑦ USB Connection	⑬ Transmitter 1 Input Volume
② Noise Cancellation Status	⑧ Headphone Connection	⑭ Transmitter 2 Remaining Recording Time
③ Screen Lock Status	⑨ Receiver Battery Level	⑮ Transmitter 2 Signal Strength
④ Transmitter 1 Battery Level	⑩ Transmitter 1 Identifier	⑯ Transmitter 2 Battery Level
⑤ Transmitter 2 Identifier	⑪ Transmitter 1 Signal Strength	⑰ Transmitter 2 Input Volume
⑥ 3.5mm Audio Output Connection	⑫ Transmitter 1 Remaining Recording Time	

Display Description

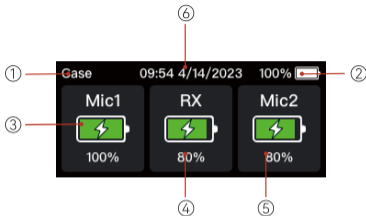

B: Receiver Main Interface (in the Charging Case)

①	The Receiver Is in the Charging Case	④	Receiver Battery Level
②	Charging Case Battery Level	⑤	Transmitter 2 Battery Level
③	Transmitter 1 Battery Level	⑥	Date & Time

Display Description



C: Receiver Output Volume Interface

-
- ① Output Volume in Mono Mode ② Output Volume Bar in Mono Mode
-

Settings: To enter the output volume settings interface from the main interface, simply rotate the control knob. You can adjust the output volume in mono mode by rotating the control knob or sliding the output volume bar.

Display Description

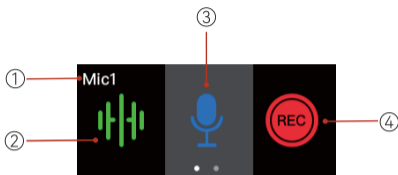

D: Receiver Quick Settings Interface

①	Quick Settings Interface for Transmitter 1	③	Mute Switch
②	ENC Switch	④	Recording Switch

Settings: To enter the quick settings interface for transmitter 1 or transmitter 2 from the main interface, simply tap on the corresponding transmitter area. You can switch between the functions on the quick settings interface by rotating the control knob or tapping the function icons. To return to the main interface, simply tap the on-screen home button.

Display Description

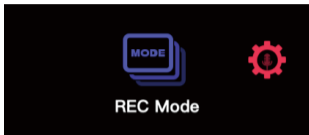

E: Receiver Menu Interface

Settings: Press the control knob to enter the menu interface from the main interface. Rotate the control knob or tap on the touchscreen to select a menu, and then press the control knob or tap the menu to enter its sub-menu interface. To return to the previous interface, simply tap the on-screen home button.

Indicator Description

Transmitter Status Indicator

Pattern	Description
Blue light flashing quickly	Pairing
Blue light flashing slowly	Disconnected from the receiver
Steady blue light	Connected to the receiver
Steady green light	ENC ON & Connected to the receiver
Steady pink light	Upgrading
Steady red light	Mute ON
Breathing red light flashing	Low battery
Breathing orange light, returning to the previous state after 5 seconds	Power ON & Charging
Breathing orange light	Power OFF & Charging
Steady orange light	Power OFF & Fully charged

Indicator Description

Transmitter REC Indicator

Pattern	Description
Steady red light	Recording
Light OFF	Not recording

Charging Case Indicator

Pattern	Description
One light outside the charging case flashing when the charging case is connected via USB	Charging case in charging mode
Four steady lights outside the charging case	Charging case fully charged
Breathing light inside the charging case	Transmitter/Receiver in charging mode
Steady light inside the charging case	Transmitter/Receiver fully charged

Indicator Description

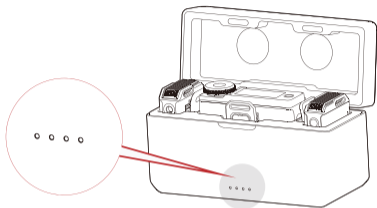

Pattern	Battery Level
One LED ON, flashing red	Low battery. The transmitter and the receiver cannot be charged using the charging case.
One LED ON	25%
Two LEDs ON	50%
Three LEDs ON	75%
Four LEDs ON	100%

Receiver Menu Description

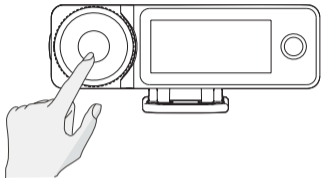

Press the control knob to enter the menu interface from the main interface. The menu operations are as follows:

1. Select **REC Mode** to set the receiver output mode.
 - a. **Stereo**
 - b. **Mono**
 - c. **Safety Track**

Note: The safety track mode is only supported when a camera is connected. When third-party apps are used for recording, it is recommended to select the mono mode.

Receiver Menu Description

2. Select **Mic Settings** to set the transmitter parameters.
 - a. **Mic Gain:** Press the control knob or tap to adjust the transmitter input gain.
 - b. **Auto Record:** The default value is **OFF**. If **Auto Record** is set to **ON**, the transmitter will automatically start internal recording when it is turned on.
 - c. **REC Stop Lock:** The default value is **OFF**. If **REC Stop Lock** is set to **ON**, recording cannot be stopped on the transmitter and can only be stopped on the receiver.
 - d. **Auto OFF:** The default value is **15min**, indicating that the transmitter will automatically turn off when it is not paired with the receiver and there is no operation of it within 15 minutes. If **Auto OFF** is set to **Never**, the transmitter will not turn off automatically.
 - e. **LED Brightness:** The default value is **Normal**. It allows you to set the brightness of the transmitter status indicator light. You can set it to **Low** as required.
 - f. **Storage:** Press the control knob or tap to view the remaining recording time of the transmitter and format the transmitter storage (when the storage is full, the earliest recording file will be automatically deleted).
3. Select **Phone Speaker** to set whether audio can be played on the phone speaker without unplugging the receiver from the mobile phone.
 - a. **OFF:** Audio play on the phone speaker is disabled.
 - b. **ON:** Audio can be played on the phone speaker without unplugging the receiver from the mobile phone.

Receiver Menu Description

4. Select **EQ** to configure audio settings.
 - a. **Hi-Fi:** Select this mode to ensure Hi-Fi audio pickup with high restoration.
 - b. **Low Cut:** Select this mode to filter low-frequency sound.
 - c. **Vocal Boost:** Select this mode to increase voice intelligibility.

5. Select **System Settings** to configure system settings.
 - a. **Pairing:** Press the control knob or tap to set the receiver to pairing mode.
 - b. **Brightness:** Press the control knob or tap to adjust the brightness of the receiver touchscreen.
 - c. **Upgrade Mode:** Press the control knob or tap to activate the device upgrade process.
 - d. **Date:** Press the control knob or tap to set the date for the receiver. The settings will be synchronized to the connected transmitter.
 - e. **Time:** Press the control knob or tap to set the time for the receiver. The settings will be synchronized to the connected transmitter.
 - f. **Language:** Press the control knob or tap to set the device language to English or Chinese.
 - g. **Factory Reset:** Press the control knob or tap to reset the device to the default settings.
 - h. **Version Info:** Press the control knob or tap to check the receiver firmware version, connected transmitter firmware version, and SN.

Operation Instructions

The preferred position for attaching the transmitter is the collar near the speaker's neck area. If the speaker's voice is louder, position the transmitter in the upper chest area. The transmitter can be attached via its back clip or the clip magnet.

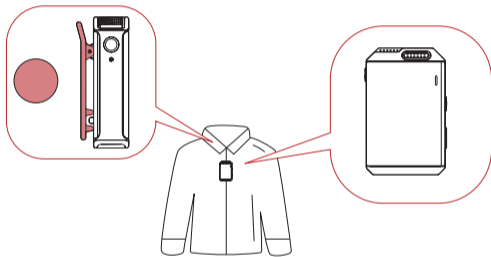

Note: Placement of the transmitter in different positions will result in recorded sound volume fluctuations. Avoid any obstructions of the transmitter during recording. It is recommended to use the furry windshield to prevent audio interference when using the transmitter outdoors.

Operation Instructions

Connecting the Receiver to an iPhone

1. Connect the receiver to an iPhone using a USB-C to Lightning cable.
2. A USB connection icon will be displayed on the receiver touchscreen.
3. Open the recorder or camera app on the mobile phone to start recording.

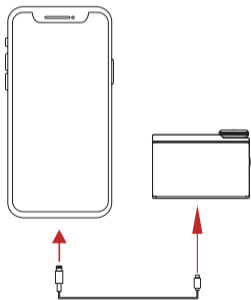

Operation Instructions

Connecting the Receiver to an Android Phone with a USB-C Interface

1. Connect the receiver to an Android phone with a USB-C interface using a USB-C to USB-C cable.
2. A USB connection icon will be displayed on the receiver touchscreen.
3. Open the recorder or camera app on the mobile phone to start recording.

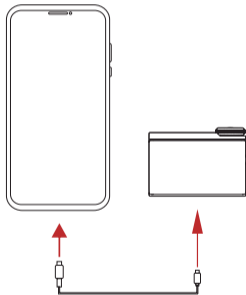

Note: It is recommended to use the original USB-C to Lightning and USB-C to USB-C cables. Otherwise, compatibility issues may occur, which could result in sound distortion or other audio problems.

Operation Instructions

Connecting the Receiver to a Camera

1. Attach the receiver to a camera via the hot shoe or cold shoe using the back clip.
2. Connect the 3.5mm audio output interface on the receiver to the 3.5mm audio input interface on the camera using a 3.5mm TRS to 3.5mm TRS cable.
3. Set the recording volume of the camera to the lowest and the output volume of the receiver to the medium to ensure the best recording level.

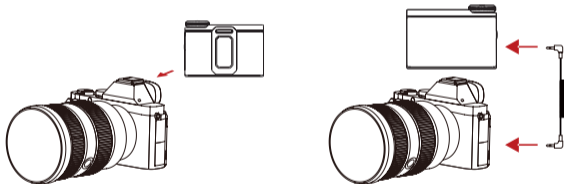

Operation Instructions

Pairing

The transmitter and the receiver are paired by default. Follow either of the following two ways to pair the transmitter and the receiver if they are disconnected.

1. Auto pairing: Place the transmitter and the receiver in the charging case, and they will pair automatically. (Figure 1)
2. Manual pairing: Turn on the transmitter and the receiver, and press and hold the pairing button on the transmitter to enter pairing mode. In this case, the transmitter status indicator light flashes quickly. Then, select **System Settings** on the receiver touchscreen and tap **Pairing** to start pairing. If the transmitter status indicator light turns steady blue, pairing is successful. (Figure 2)

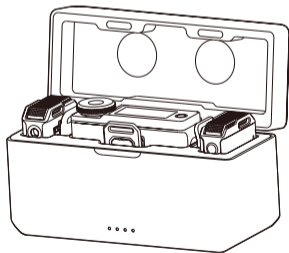

Figure 1

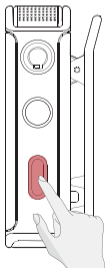
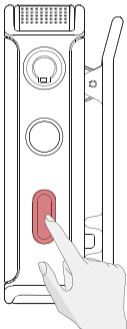

Figure 2

Operation Instructions

Noise Cancellation

Press the noise cancellation button on the transmitter to enable the noise cancellation function. In this case, the transmitter status indicator light turns green.



Recording

Press the REC button on the transmitter to enable the recording function. In this case, the transmitter REC indicator light turns steady red.

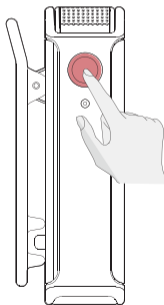

Operation Instructions

Mute

Press the power button on the transmitter twice to mute the transmitter. In this case, the transmitter status indicator light turns steady red.

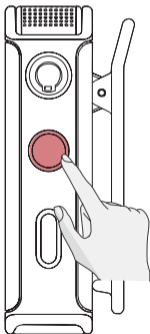

Screen Lock

Press the power/screen lock button on the receiver to lock the screen to avoid unexpected operations, except for turning the device on or off. To unlock the screen, simply press the button again.

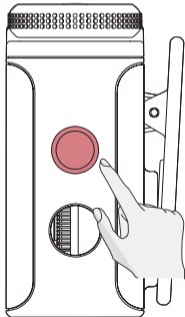

Operation Instructions

Transmitter Recording

1. After turning on the transmitter, press the REC button to start recording. In this case, the transmitter REC indicator light turns steady red. Press the REC button again to stop recording.
2. The recorded audio format of the transmitter is lossless 48 kHz/24-bit mono WAV — an unprocessed RAW file. When the recording lasts for an extended period, the file will be split up automatically every 30 minutes.
3. The transmitter is supported with 8GB of built-in memory for storing the recording files automatically. If the storage is full, newly recorded audio will overwrite the older recorded audio automatically.
4. The recording file can be exported by connecting the transmitter to a computer or mobile phone.
5. The transmitter storage can be formatted via the receiver or other devices such as a computer or mobile phone.

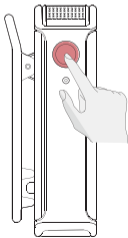

Firmware Update

When new firmware is available, update the firmware by connecting the transmitter, the receiver, and the charging case to a computer separately.

How to Update the Firmware:

Receiver Firmware Update

1. Select **System Settings** > **Upgrade Mode** from the main interface on the receiver touchscreen.
2. Connect the receiver to the computer using the USB-C cable provided and copy the firmware update file to the receiver.
3. Unplug the USB-C cable from the computer after the file is copied. Then, the receiver firmware update will start automatically and the message "Upgrading..." will be displayed on the receiver touchscreen. During the firmware update, operations of the receiver are not allowed until the message "Upgraded successfully. The device will restart soon." is displayed.
4. After the firmware is updated successfully, the receiver will restart automatically.

Firmware Update

Transmitter Firmware Update

1. Turn on the transmitter, connect the transmitter to the computer using the USB-C cable provided, and copy the firmware update file to the transmitter.
2. Unplug the USB-C cable from the computer after the file is copied. Then, the transmitter firmware update will start automatically. During the firmware update, the transmitter status indicator light turns steady pink and will return to the previous state after the firmware update is completed.
3. After the firmware is updated successfully, the transmitter will restart automatically.

Specifications

Name	LARK MAX Transmitter
Dimensions	Approx. 48.5mm x 30.3mm x 19.37mm (1.9" x 1.2" x 0.76")
Weight	Approx. 33g (1.16oz)
Transmission Range	Up to 820ft (250m) for LOS/197ft (60m) for NLOS
Modulation Mode	GFSK
EIRP	<20dBm
Operating Frequency	2400MHz-2483.5MHz
Battery Type	RoHS-compliant LiPo
Battery Capacity	300mAh
Battery Voltage	3.87V
Battery Energy	1.161Wh
Charging Temperature	0° C to 45° C
Operating Temperature	-20° C to 45° C
Charging Time	<2 hours
Operating Time	Approx. 7.5 hours

Specifications

Recording Time	Approx. 14 hours
Recorded Audio Format	48 kHz/24-bit WAV
Mic Polar Pattern	Omnidirectional
Mic Sensitivity	-36dBFS±1dB@1 kHz, 94dB SPL
Input Dynamic Range	98dB (Default)/106dB (Max)
Frequency Response	20 Hz–20 kHz (Low Cut disabled)
Signal-to-Noise Ratio	70dB
Sound Pressure Level	120dB SPL (Default)/128dB SPL (Max)
Equivalent Noise	24dBA

Note: The transmission range is measured in an unobstructed outdoor environment free of interference.

Specifications

Name	LARK MAX Receiver
Dimensions	Approx. 58mm x 40.83mm x 23.17mm (2.3" x 1.6" x 0.9")
Weight	Approx. 60g (2.1oz)
Touchscreen	1.1" AMOLED
Touchscreen Resolution	126 x 294 pixels
Modulation Mode	GFSK
EIRP	<20dBm
Operating Frequency	2400MHz–2483.5MHz
Battery Type	RoHS-compliant LiPo
Battery Capacity	490mAh
Battery Voltage	3.87V
Battery Energy	1.896Wh
Charging Temperature	0° C to 45° C
Operating Temperature	-20° C to 45° C
Charging Time	<2 hours
Operating Time	Approx. 9 hours

Specifications

Name	LARK MAX Charging Case
Dimensions	Approx. 115mm x 46mm x 63mm (4.5" x 1.8" x 2.5")
Weight	Approx. 193.5g (6.8oz)
Battery Type	RoHS-compliant LiPo
Battery Capacity	2800mAh
Battery Voltage	3.85V
Battery Energy	10.78Wh
Charging Time	<2 hours
Operating Temperature	-20° C to 45° C
Charging Temperature	0° C to 45° C
Max Charging Times	Approx. two times of charging for 2 TX and 1 RX

Note: The data provided above is based on laboratory testing results.

Disclaimer

1. Please read and follow all the instructions carefully.
2. Please note all the warnings.
3. Do not place the product near or inside heating devices (including but not limited to microwave ovens, induction cookers, electric ovens, electric heaters, pressure cookers, water heaters, and gas stoves) to prevent the battery from overheating and exploding.
4. Use only parts and accessories specified or provided by Hollyland. The use of non-original parts or accessories may cause electric shock, fire, explosion, or other dangers.
5. Please hand over all maintenance work to qualified personnel. No matter what kind of damage the product suffers, such as damage to the power cable or plug, liquid penetration, objects falling into the product, rain, dampness, failure to work normally, or fall, maintenance is required.

Compliance Information

CE Compliance Notice:



- **EU Declaration of Conformity**

Hollyland hereby declares that the device is in compliance with the essential requirements and other relevant provisions of directives 2014/53/EU, 2011/65/EU and (EU)2015/863.

The original EU declaration of conformity may be found at www.hollyland.com.

- **National restrictions**

This device may be used in all member states of the EU and Northern Ireland.

	AT	BE	BG	CH	CY	CZ	DE
	DK	EE	EL	ES	FI	FR	HR
	HU	IE	IS	IT	LI	LT	LU
	LV	MT	NL	NO	PL	PT	RO
	SE	SI	SK	TR	UK(NI)		

Compliance Information

- **CAUTION**

RISK OF EXPLOSION IF BATTERY IS REPLACED BY AN INCORRECT TYPE. DISPOSE OF USED BATTERIES ACCORDING TO THE INSTRUCTIONS.

- **RECYCLING**

This product bears the selective sorting symbol for Waste electrical and electronic equipment (WEEE). This means that this product must be handled pursuant to European directive 2012/19/EU in order to be recycled or dismantled to minimize its impact on the environment. User has the choice to give his product to a competent recycling organization or to the retailer when he buys a new electrical or electronic equipment.



Compliance Information

FCC Requirement:



FCC ID:2ADZC-6902T FCC ID:2ADZC-6902R

Any changes or modifications not expressly approved by the party responsible for compliance could void the user's authority to operate the equipment. This device complies with Part 15 of the FCC Rules. Operation is subject to the following two conditions: (1) this device may not cause harmful interference, and (2) this device must accept any interference received, including interference that may cause undesired operation.

FCC Radiation Exposure Statement:

The device has been tested and found to comply with FCC SAR limits.

Compliance Information

Note:

This equipment has been tested and found to comply with the limits for a Class B digital device, pursuant to Part 15 of the FCC Rules. These limits are designed to provide reasonable protection against harmful interference in a residential installation. This equipment generates, uses, and can radiate radio frequency energy and, if not installed and used in accordance with the instructions, may cause harmful interference to radio communications. However, there is no guarantee that interference will not occur in a particular installation. If this equipment does cause harmful interference to radio or television reception, which can be determined by turning the equipment off and on, the user is encouraged to try to correct the interference by one or more of the following measures:

- Reorient or relocate the receiving antenna.
- Increase the separation between the equipment and receiver.
- Connect the equipment into an outlet on a circuit different from that to which the receiver is connected.
- Consult the dealer or an experienced radio/TV technician for help.

Compliance Information

UK Compliance Notice



- UK Declaration of Conformity

Hollyland hereby declares that the device is in compliance with the essential requirements and other relevant provisions of the Radio Equipment Regulations 2017.

The original UK declaration of conformity may be found at www.hollyland.com.

- National restrictions

This device may only be used indoors in Great Britain.



NCC Compliance Notice:



CCAJ23LP1CB0T9



CCAJ23LP1CC0T2

取得審驗證明之低功率射頻器材，非經核准，公司、商號或使用者均不得擅自變更頻率、加大功率或變更原設計之特性及功能。低功率射頻器材之使用不得影響飛航安全及干擾合法通信；經發現有干擾現象時，應立即停用，並改善至無干擾時方得繼續使用。前述合法通信，指依電信管理法規定作業之無線電通信。低功率射頻器材須忍受合法通信或工業、科學及醫療用電波輻射性電機設備之干擾。

Compliance Information

Triman



Points de collecte sur www.quefairedemesdechets.fr

FR

Vous êtes responsable de remettre tous les appareils électriques et électroniques usagés à des points de collecte correspondants.

Pour en savoir plus:
www.quefairedemesdechets.fr

MIC Certification:



® 216-230030



® 216-230031

Support

If you encounter any problems in using the product or need any help, please contact Hollyland Support Team via the following ways:

 Hollyland User Group

 HollylandTech

 HollylandTech

 HollylandTech

 support@hollyland.com

 www.hollyland.com

Statement

All copyrights belong to Shenzhen Hollyland Technology Co., Ltd. Without the written approval of Shenzhen Hollyland Technology Co., Ltd., no organization or individual may copy or reproduce part or all of any written or illustrative content and disseminate it in any form.

Trademark Statement

All the trademarks are owned by Shenzhen Hollyland Technology Co., Ltd.

Note:

Due to product version upgrades or other reasons, this User Manual will be updated from time to time. Unless otherwise agreed, this document is provided as a guide for use only. All representations, information, and recommendations in this document do not constitute warranties of any kind, express, or implied.